



# Bench

by Links Contract



2022-OCT



Our innovative Bench series boasts sleek, stylish components that promote diversity and simplicity. All floor standing units come standard with adjustable glides, while a polished metal support frame finishes our attractive new series.

Bench by Links is a creative fusion of stylish design, aesthetics and functional modularity. This freestanding benching system lends a unique lightness while also being exceedingly practical for daily usage.

Bench offers units for storage space, mounted hutches, privacy panels, upholstered seat cushions, surface mount electrics and a cable management tray. These features create working environments that are alive and inspirational in many kinds of offices. From classic offices to open concept layouts, the endless possibilities of the Bench series will surely enhance creativity and productivity in the workplace.

#### **A wide range of options**

Bench consists of a minimum of modules that can be combined in various ways to suit different needs to create workstations and storage space.

The Bench system can be adapted to the needs of companies that seek contemporary office design and a workplace with a clear identity. The system, the desks and modules are easy to install and reconfigure.

#### **Individual & Multiple work areas**

Bench employs a design that is not often found in office areas, and comes in friendly colours that give every office a cosy vibrant touch. The design serves to create a vitalising and inspiring work environment in all kinds of offices from open-plan studios to minimalistic individual offices.

#### **Simple cable management**

Electrical cables feed through to cable trays that run horizontally under the unit and easily connect to any existing electrical outlet.

**Bench At A Glance**

**2 Workstations**

TR1, TR2  
TR4, TR6  
TR2A, TR3A  
TRR, TRL

**8 Pedestals**

Mobile Pedestals

**9 Cabinets**

Cabinets - 22”H

**10 Credenzas and Cushions**

Credenzas - 22”H  
Seat Cushions

**13 Post Mounted Hutches**

20” High Hutch (6” Posts)

**14 Bench Panels and Accessories**

Divider Panel Set

**15 Bench Electrical and Accessories**

Wire Management Tray  
Power/Data Center  
Bench Modesty Panels

**16 Collaborative Power Options (Daisy Chain)**

**18 Tables**

**20 Electrical Placement Options, Specifications**

**21 Specifications**

**22 Links Contract Furniture At A Glance**



**Bench TR1**

Work table. Free standing 24"D or 30"D work surface.

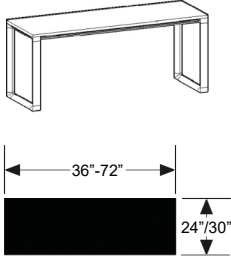

CODE	PRICE	WIDTH (in/mm)	DEPTH (in/mm)	HEIGHT (in/mm)	VOLUME (ft3/m3)	WEIGHT (lbs/kg)
------	-------	---------------	---------------	----------------	-----------------	-----------------

24"D	TR1-2436-C	702	36/914	24/610	29.5/749	6.0/0.17	33/15
	TR1-2442-C	736	42/1067	24/610	29.5/749	6.4/0.18	36/16
	TR1-2448-C	766	48/1219	24/610	29.5/749	6.8/0.19	40/18
	TR1-2454-C	797	54/1372	24/610	29.5/749	7.2/0.20	44/20
	TR1-2460-C	826	60/1524	24/610	29.5/749	7.2/0.20	46/21
	TR1-2466-C	889	66/1676	24/610	29.5/749	7.2/0.20	50/23
	TR1-2472-C	952	72/1829	24/610	29.5/749	7.3/0.21	55/25
30"D	TR1-3036-C	781	<b>36/914</b>	<b>30/762</b>	<b>29.5/749</b>	<b>6.6/0.19</b>	<b>38/17</b>
	TR1-3042-C	811	42/1067	30/762	29.5/749	7.0/0.20	42/19
	TR1-3048-C	844	48/1219	30/762	29.5/749	7.4/0.21	48/22
	TR1-3054-C	874	54/1372	30/762	29.5/749	7.9/0.22	54/24
	TR1-3060-C	904	60/1524	30/762	29.5/749	7.9/0.22	57/26
	TR1-3066-C	966	66/1676	30/762	29.5/749	7.9/0.22	62/28
	TR1-3072-C	1031	72/1829	30/762	29.5/749	8.1/0.23	66/30
20"D	TR1-2042-C-42	810	42/1067	20/508	42/1067	7.4/0.21	46/21
	TR1-2048-C-42	843	48/1219	20/508	42/1067	7.8/0.22	50/23
	TR1-2054-C-42	877	54/1372	20/508	42/1067	8.2/0.23	54/24
	TR1-2060-C-42	909	60/1524	20/508	42/1067	8.2/0.23	56/25
	TR1-2066-C-42	978	66/1676	20/508	42/1067	8.2/0.23	60/27
	TR1-2072-C-42	1047	72/1829	20/508	42/1067	8.3/0.24	65/29
24"D	TR1-2442-C-42	810	42/1067	24/610	42/1067	7.4/0.21	46/21
	TR1-2448-C-42	843	48/1219	24/610	42/1067	7.8/0.22	50/23
	TR1-2454-C-42	877	54/1372	24/610	42/1067	8.2/0.23	54/24
	TR1-2460-C-42	909	60/1524	24/610	42/1067	8.2/0.23	56/25
	TR1-2466-C-42	978	66/1676	24/610	42/1067	8.2/0.23	60/27
	TR1-2472-C-42	1047	72/1829	24/610	42/1067	8.3/0.24	65/29

**Bench TR2**

Work table. Two person, connected 24"D or 30"D work surfaces.

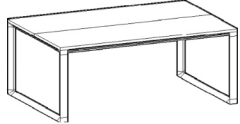

For configurations with divider panels add "-G" to desk code. i.e. TR2-2472-G-C

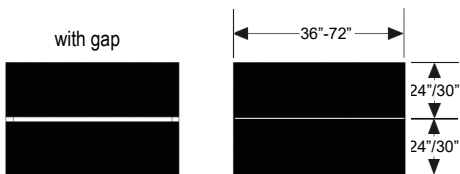
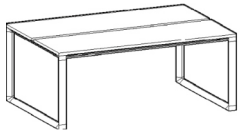

24"D	TR2-2436-C	984	36/914	48/1219	29.5/749	9.8/0.28	65/29
	TR2-2442-C	1031	42/1067	48/1219	29.5/749	10.1/0.29	73/33
	TR2-2448-C	1072	48/1219	48/1219	29.5/749	10.5/0.30	80/36
	TR2-2454-C	1116	54/1372	48/1219	29.5/749	10.9/0.31	82/37
	TR2-2460-C	1158	60/1524	48/1219	29.5/749	10.9/0.31	85/39
	TR2-2466-C	1244	66/1676	48/1219	29.5/749	10.9/0.31	95/43
	TR2-2472-C	1331	72/1829	48/1219	29.5/749	11.0/0.31	110/50
30"D	TR2-3036-C	1093	36/914	60/1524	29.5/749	10.2/0.29	76/34
	TR2-3042-C	1138	42/1067	60/1524	29.5/749	10.7/0.30	84/38
	TR2-3048-C	1181	48/1219	60/1524	29.5/749	11.1/0.31	95/43
	TR2-3054-C	1224	54/1372	60/1524	29.5/749	11.6/0.33	108/49
	TR2-3060-C	1266	60/1524	60/1524	29.5/749	11.6/0.33	114/52
	TR2-3066-C	1354	66/1676	60/1524	29.5/749	11.6/0.33	123/56
	TR2-3072-C	1439	72/1829	60/1524	29.5/749	11.8/0.33	133/60

For additional specification instructions see pages 20-21.

Refer to pages 15-17 for electrical options.

Divider panel sets and components available starting on page 14.

**Bench TR4**

Work table. Four person, connected 24"D or 30"D work surfaces.

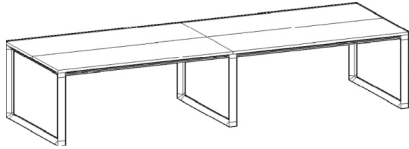

For configurations with divider panels add "-G" to desk code.  
 i.e. TR4-2472-G-C

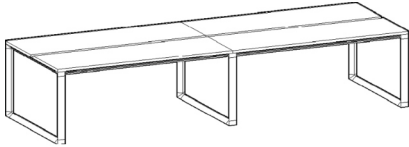

with gap



CODE	PRICE	WIDTH (in/mm)	DEPTH (in/mm)	HEIGHT (in/mm)	VOLUME (ft3/m3)	WEIGHT (lbs/kg)
------	-------	------------------	------------------	-------------------	--------------------	--------------------

24"D	TR4-2436-C	1870	72/1829	48/1219	29.5/749	14.9/0.42	130/59
	TR4-2442-C	1954	84/2134	48/1219	29.5/749	15.6/0.44	145/66
	TR4-2448-C	2035	96/2438	48/1219	29.5/749	16.2/0.46	160/73
	TR4-2454-C	2119	108/2743	48/1219	29.5/749	16.9/0.48	165/75
	TR4-2460-C	2200	120/3048	48/1219	29.5/749	16.9/0.48	169/77
	TR4-2466-C	2362	132/3353	48/1219	29.5/749	16.9/0.48	190/86
	TR4-2472-C	2527	144/3658	48/1219	29.5/749	17.0/0.48	220/100
30"D	TR4-3036-C	2077	72/1829	60/1524	29.5/749	15.9/0.45	152/69
	TR4-3042-C	2159	84/2134	60/1524	29.5/749	16.6/0.47	175/79
	TR4-3048-C	2240	96/2438	60/1524	29.5/749	17.6/0.50	190/86
	TR4-3054-C	2324	108/2743	60/1524	29.5/749	18.4/0.52	210/95
	TR4-3060-C	2405	120/3048	60/1524	29.5/749	18.4/0.52	228/103
	TR4-3066-C	2569	132/3353	60/1524	29.5/749	18.4/0.52	246/112
	TR4-3072-C	2732	144/3658	60/1524	29.5/749	18.5/0.52	265/120

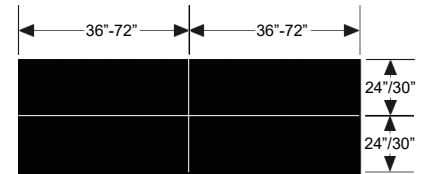

**Bench TR6**

Work table. Six person, connected 24"D or 30"D work surfaces.

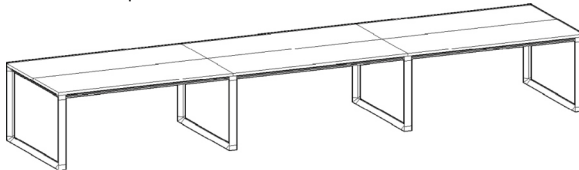

For configurations with divider panels add "-G" to desk code.  
 i.e. TR6-2472-G-C

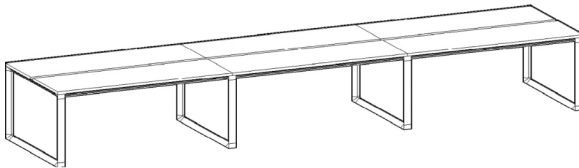

with gap



24"D	TR6-2436-C	2993	108/2743	48/1219	29.5/749	20.5/0.58	195/88
	TR6-2442-C	3124	126/3200	48/1219	29.5/749	21.6/0.61	228/103
	TR6-2448-C	3253	144/3658	48/1219	29.5/749	22.7/0.64	240/109
	TR6-2454-C	3389	162/4115	48/1219	29.5/749	23.8/0.67	249/113
	TR6-2460-C	3518	180/4572	48/1219	29.5/749	23.8/0.67	254/115
	TR6-2466-C	3782	198/5029	48/1219	29.5/749	23.8/0.67	285/129
	TR6-2472-C	4044	216/5486	48/1219	29.5/749	24.0/0.68	330/150
30"D	TR6-3036-C	3320	108/2743	60/1524	29.5/749	22.0/0.62	228/103
	TR6-3042-C	3451	126/3200	60/1524	29.5/749	23.3/0.66	250/113
	TR6-3048-C	3584	144/3658	60/1524	29.5/749	24.7/0.70	285/129
	TR6-3054-C	3716	162/4115	60/1524	29.5/749	26.0/0.74	315/143
	TR6-3060-C	3848	180/4572	60/1524	29.5/749	26.0/0.74	342/155
	TR6-3066-C	4111	198/5029	60/1524	29.5/749	26.0/0.74	369/167
	TR6-3072-C	4372	216/5486	60/1524	29.5/749	26.5/0.75	398/181

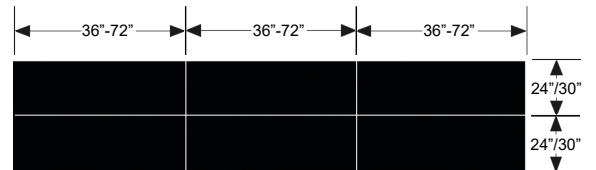

For additional specification instructions see pages 20-21.

Refer to pages 15-17 for electrical options.

Divider panel sets and components available starting on page 14.

**Bench TR2A**

Work table. Two person, connected 24"D or 30"D work surfaces.

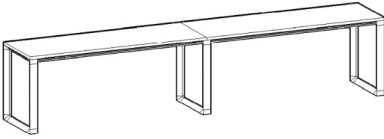

			WIDTH	DEPTH	HEIGHT	VOLUME	WEIGHT
CODE	PRICE	(in/mm)	(in/mm)	(in/mm)	(ft3/m3)	(lbs/kg)	
24"D	TR2A-2436-C	1309	72/1829	24/610	29.5/749	7.6/0.22	60/27
	TR2A-2442-C	1373	84/2134	24/610	29.5/749	8.0/0.23	67/30
	TR2A-2448-C	1438	96/2438	24/610	29.5/749	8.4/0.24	75/34
	TR2A-2454-C	1504	108/2743	24/610	29.5/749	8.7/0.25	83/38
	TR2A-2460-C	1565	120/3048	24/610	29.5/749	8.7/0.25	87/39
	TR2A-2466-C	1693	132/3353	24/610	29.5/749	8.7/0.25	95/43
	TR2A-2472-C	1824	144/3658	24/610	29.5/749	8.8/0.25	105/48
30"D	TR2A-3036-C	1468	72/1829	30/762	29.5/749	8.1/0.23	71/32
	TR2A-3042-C	1534	84/2134	30/762	29.5/749	8.6/0.24	79/36
	TR2A-3048-C	1598	96/2438	30/762	29.5/749	9.1/0.26	90/41
	TR2A-3054-C	1662	108/2743	30/762	29.5/749	9.5/0.27	103/47
	TR2A-3060-C	1727	120/3048	30/762	29.5/749	9.5/0.27	109/49
	TR2A-3066-C	1854	132/3353	30/762	29.5/749	9.5/0.27	118/54
	TR2A-3072-C	1985	144/3658	30/762	29.5/749	9.6/0.27	128/58

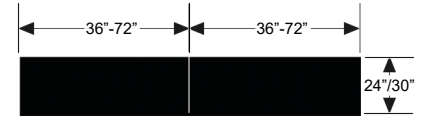

**Bench TR3A**

Work table. Three person, connected 24"D or 30"D work surfaces.

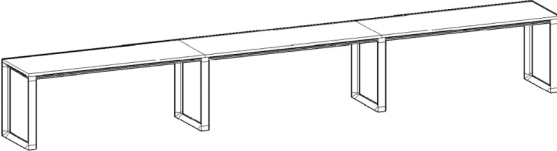

24"D	TR3A-2436-C	1885	108/2743	24/610	29.5/749	9.4/0.27	88/40
	TR3A-2442-C	1981	126/3200	24/610	29.5/749	9.8/0.28	98/44
	TR3A-2448-C	2080	144/3658	24/610	29.5/749	10.2/0.29	110/50
	TR3A-2454-C	2178	162/4115	24/610	29.5/749	10.5/0.30	122/55
	TR3A-2460-C	2270	180/4572	24/610	29.5/749	12.5/0.35	128/58
	TR3A-2466-C	2464	198/5029	24/610	29.5/749	13.1/0.37	140/64
	TR3A-2472-C	2659	216/5486	24/610	29.5/749	13.6/0.39	155/70
30"D	TR3A-3036-C	2126	108/2743	30/762	29.5/749	9.9/0.28	104/47
	TR3A-3042-C	2224	126/3200	30/762	29.5/749	10.4/0.29	116/53
	TR3A-3048-C	2322	144/3658	30/762	29.5/749	10.9/0.31	133/60
	TR3A-3054-C	2419	162/4115	30/762	29.5/749	11.3/0.32	152/69
	TR3A-3060-C	2510	180/4572	30/762	29.5/749	11.3/0.32	161/73
	TR3A-3066-C	2705	198/5029	30/762	29.5/749	11.3/0.32	175/79
	TR3A-3072-C	2900	216/5486	30/762	29.5/749	11.4/0.32	189/86

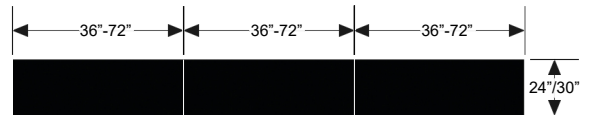

For additional specification instructions see pages 20-21.

Refer to pages 15-17 for electrical options.

Divider panel sets and components available starting on page 14.







**Bench TRL**

Work table. 24"D or 30"D worksurface with 24"D x 36"-48" return on left side.

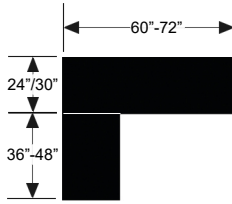
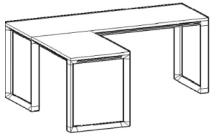

CODE	PRICE	WIDTH (in/mm)	DEPTH (in/mm)	HEIGHT (in/mm)	VOLUME (ft3/m3)	WEIGHT (lbs/kg)
TRL-2460-2436-C	1379	60/1524	60/1524	29.5/749	8.3/0.24	65/29
TRL-2460-2442-C	1408	60/1524	66/1676	29.5/749	8.3/0.24	70/32
TRL-2460-2448-C	1439	60/1524	72/1829	29.5/749	8.3/0.24	75/34
TRL-2466-2436-C	1434	66/1676	60/1524	29.5/749	8.6/0.24	70/32
TRL-2466-2442-C	1464	66/1676	66/1676	29.5/749	8.6/0.24	75/34
TRL-2466-2448-C	1495	66/1676	72/1829	29.5/749	8.6/0.24	80/36
TRL-2472-2436-C	1489	72/1829	60/1524	29.5/749	8.9/0.25	78/35
TRL-2472-2442-C	1519	72/1829	66/1676	29.5/749	8.9/0.25	83/38
TRL-2472-2448-C	1550	72/1829	72/1829	29.5/749	8.9/0.25	88/40
TRL-3060-2436-C	1446	60/1524	66/1676	29.5/749	9.0/0.25	80/36
TRL-3060-2442-C	1478	60/1524	72/1829	29.5/749	9.0/0.25	85/39
TRL-3060-2448-C	1510	60/1524	78/1981	29.5/749	9.0/0.25	90/41
TRL-3066-2436-C	1504	66/1676	66/1676	29.5/749	9.3/0.26	84/38
TRL-3066-2442-C	1534	66/1676	72/1829	29.5/749	9.3/0.26	89/40
TRL-3066-2448-C	1565	66/1676	78/1981	29.5/749	9.3/0.26	94/43
TRL-3072-2436-C	1559	72/1829	66/1676	29.5/749	9.7/0.27	89/40
TRL-3072-2442-C	1590	72/1829	72/1829	29.5/749	9.7/0.27	94/43
TRL-3072-2448-C	1620	72/1829	78/1981	29.5/749	9.7/0.27	99/45

**Bench TRR**

Work table. 24"D or 30"D worksurface with 24"D x 36"-48" return on right side.

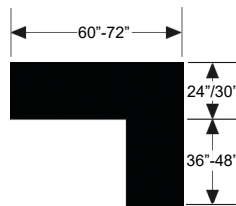
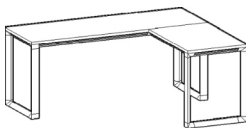

TRR-2460-2436-C	1379	60/1524	60/1524	29.5/749	8.3/0.24	65/29
TRR-2460-2442-C	1408	60/1524	66/1676	29.5/749	8.3/0.24	70/32
TRR-2460-2448-C	1439	60/1524	72/1829	29.5/749	8.3/0.24	75/34
TRR-2466-2436-C	1434	66/1676	60/1524	29.5/749	8.6/0.24	70/32
TRR-2466-2442-C	1464	66/1676	66/1676	29.5/749	8.6/0.24	75/34
TRR-2466-2448-C	1495	66/1676	72/1829	29.5/749	8.6/0.24	80/36
TRR-2472-2436-C	1489	72/1829	60/1524	29.5/749	8.9/0.25	78/35
TRR-2472-2442-C	1519	72/1829	66/1676	29.5/749	8.9/0.25	83/38
TRR-2472-2448-C	1550	72/1829	72/1829	29.5/749	8.9/0.25	88/40
TRR-3060-2436-C	1446	60/1524	66/1676	29.5/749	9.0/0.25	80/36
TRR-3060-2442-C	1478	60/1524	72/1829	29.5/749	9.0/0.25	85/39
TRR-3060-2448-C	1510	60/1524	78/1981	29.5/749	9.0/0.25	90/41
TRR-3066-2436-C	1504	66/1676	66/1676	29.5/749	9.3/0.26	84/38
TRR-3066-2442-C	1534	66/1676	72/1829	29.5/749	9.3/0.26	89/40
TRR-3066-2448-C	1565	66/1676	78/1981	29.5/749	9.3/0.26	94/43
TRR-3072-2436-C	1559	72/1829	66/1676	29.5/749	9.7/0.27	89/40
TRR-3072-2442-C	1590	72/1829	72/1829	29.5/749	9.7/0.27	94/43
TRR-3072-2448-C	1620	72/1829	78/1981	29.5/749	9.7/0.27	99/45

For additional specification instructions see pages 20-21.

Refer to pages 15-17 for electrical options.

Divider panel sets and components available starting on page 14.

**Mobile Pedestals**

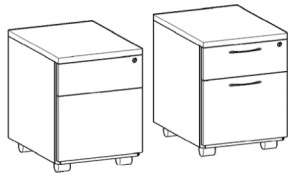

Mobile pedestal on casters. One box and one file drawer with ball bearing suspension on the file drawer and on box drawer. Locking drawers. Four casters.

P - Specify pull handle style

CODE	PRICE	WIDTH (in/mm)	DEPTH (in/mm)	HEIGHT (in/mm)	VOLUME (ft3/m3)	WEIGHT (lbs/kg)
------	-------	---------------	---------------	----------------	-----------------	-----------------

CAB-1622-TMBF	779	16/406	22/559	21/533	5/0.14	65/29
CAB-1622-TMBF-P	835	With optional handles				

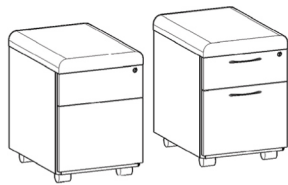

Mobile pedestal on casters. One box and one file drawer with ball bearing suspension on the file drawer and on box drawer. Locking drawers. Four casters. Cushioned seat. Refer to Links Fabric cards for available fabric selection.

P - Specify pull handle style

CAB-1622-TMBF-SE	1104	16/406	22/559	24/610	6/0.17	65/29
CAB-1622-TMBF-SE-P	1160	With optional handles				

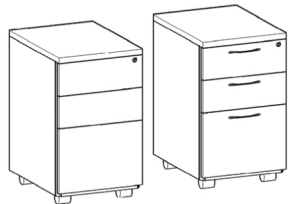

Mobile pedestal on casters. Two box and one file drawer with ball bearing suspension on the file drawer and on box drawer. Locking drawers. Four casters.

P - Specify pull handle style

CAB-1622-TMBBF	862	16/406	22/559	26.5/673	6/0.17	80/36
CAB-1622-TMBBF-P	946	With optional handles				

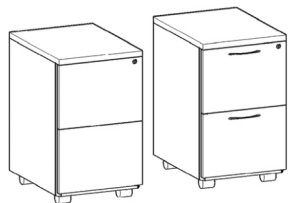

Mobile pedestal on casters. Two file drawer with ball bearing suspension on both drawers. Locking drawers. Four casters.

P - Specify pull handle style

CAB-1622-TMFF	862	16/406	22/559	26.5/673	6/0.17	80/36
CAB-1622-TMFF-P	918	With optional handles				

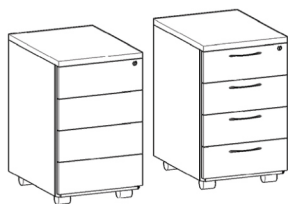

Mobile pedestal on casters. Four box drawers with ball bearing suspension. Locking drawers. Four casters.

P - Specify pull handle style

CAB-1622-TMFF	944	16/406	22/559	26.5/673	6/0.17	80/36
CAB-1622-TMFF-P	1056	With optional handles				

For additional specification instructions and pull handle options see pages 20-21. Refer to Links Fabric card for available fabric options.

**Cabinets - 22"H**

Storage cabinet with locking doors.

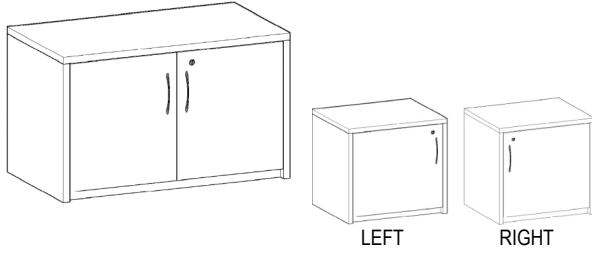

CODE	PRICE	WIDTH (in/mm)	DEPTH (in/mm)	HEIGHT (in/mm)	VOLUME (ft3/m3)	WEIGHT (lbs/kg)
------	-------	------------------	------------------	-------------------	--------------------	--------------------

CAB-2024-22-LSC-P	726	24/610	20/508	22/559	6.4/0.18	66/30
CAB-2024-22-RSC-P	726	24/610	20/508	22/559	6.4/0.18	66/30
CAB-2030-22-SC-P	758	30/762	20/508	22/559	8.0/0.23	74/34
CAB-2036-22-SC-P	788	36/914	20/508	22/559	9.6/0.27	81/37

P - Specify pull handle style

Box/File cabinet. One file drawer, one box drawer. Locking Drawers.



CAB-2024-22-BF-P	916	24/610	20/508	22/559	6.4/0.18	88/40
CAB-2030-22-BF-P	946	30/762	20/508	22/559	8.0/0.23	96/44
CAB-2036-22-BF-P	977	36/914	20/508	22/559	9.6/0.27	103/47

P - Specify pull handle style

\*MAX 30lb LOAD CAPACITY\*

Open cabinet with three adjustable shelves.

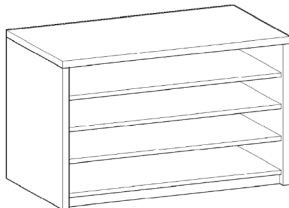

CAB-2024-22-OS	726	24/610	20/508	22/559	6.4/0.18	88/40
CAB-2030-22-OS	758	30/762	20/508	22/559	8.0/0.23	96/44
CAB-2036-22-OS	788	36/914	20/508	22/559	9.6/0.27	103/47



For additional specification instructions and pull handle options see pages 20-21.

**Credenzas - 22"H**

Double storage cabinet credenza with locking doors.

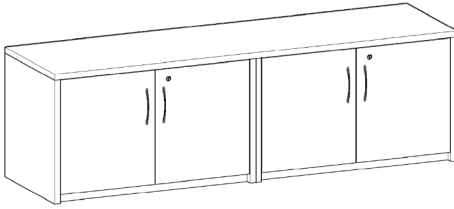

CODE	PRICE	WIDTH (in/mm)	DEPTH (in/mm)	HEIGHT (in/mm)	VOLUME (ft3/m3)	WEIGHT (lbs/kg)
------	-------	------------------	------------------	-------------------	--------------------	--------------------

CAB-2060-22-SCSC-P	1534	60/1524	20/508	22/559	16.0/0.45	148/67
CAB-2072-22-SCSC-P	1580	72/1829	20/508	22/559	19.2/0.54	162/73

P - Specify pull handle style

Double box/file cabinet credenza. One file drawer, one box drawer each cabinet. Locking Drawers.

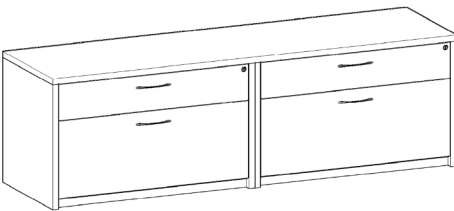

CAB-2060-22-BFBF-P	1912	60/1524	20/508	22/559	16.0/0.45	192/87
CAB-2072-22-BFBF-P	1958	72/1829	20/508	22/559	19.2/0.54	206/93

P - Specify pull handle style

Double open shelf credenza. Three adjustable shelves in each cabinet.

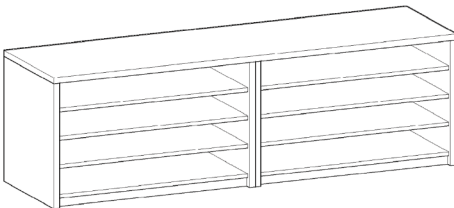

CAB-2060-22-OSOS	1534	60/1524	20/508	22/559	16.0/0.45	192/87
CAB-2072-22-OSOS	1580	72/1829	20/508	22/559	19.2/0.54	206/93

Storage cabinet, box/file credenza. One file drawer, one box drawer. Locking doors and drawers.

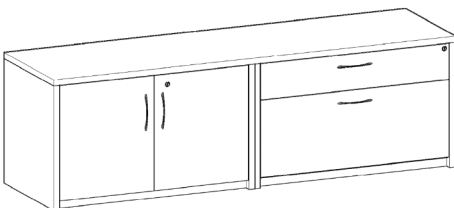

CAB-2060-22-SCBF-P	1708	60/1524	20/508	22/559	16.0/0.45	170/77
CAB-2072-22-SCBF-P	1754	72/1829	20/508	22/559	19.2/0.54	184/83

P - Specify pull handle style

Storage cabinet, bookcase credenza. Three adjustable shelves in open shelf cabinet. Locking doors on storage cabinet.

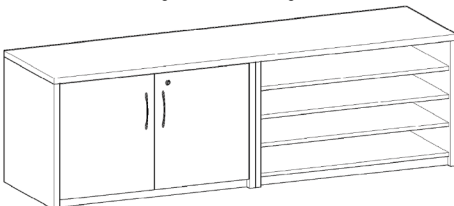

CAB-2060-22-SCOS-P	1534	60/1524	20/508	22/559	16.0/0.45	170/77
CAB-2072-22-SCOS-P	1580	72/1829	20/508	22/559	19.2/0.54	184/83

P - Specify pull handle style

For additional specification instructions and pull handle options see pages 20-21.

**Credenzas - 22"H**

Box/file cabinet, bookcase credenza. One file drawer, one box drawer. Three adjustable shelves in open shelf cabinet. Locking drawers on box/file cabinet.

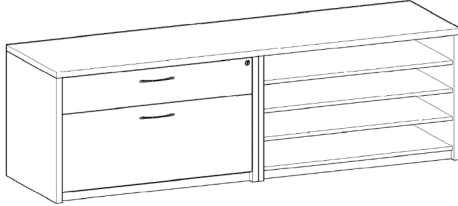

CODE	PRICE	WIDTH (in/mm)	DEPTH (in/mm)	HEIGHT (in/mm)	VOLUME (ft3/m3)	WEIGHT (lbs/kg)
------	-------	------------------	------------------	-------------------	--------------------	--------------------

CAB-2060-22-BFOS-P	1708	60/1524	20/508	22/559	16.0/0.45	192/87
CAB-2072-22-BFOS-P	1754	72/1829	20/508	22/559	19.2/0.54	206/93

P - Specify pull handle style

Box/file cabinet, storage cabinet credenza. One file drawer, one box drawer. Locking drawers and doors.

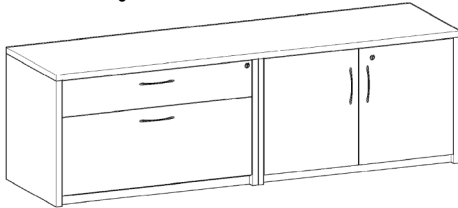

CAB-2060-22-BFSC-P	1708	60/1524	20/508	22/559	16.0/0.45	170/77
CAB-2072-22-BFSC-P	1754	72/1829	20/508	22/559	19.2/0.54	184/83

P - Specify pull handle style

Bookcase, storage cabinet credenza. Three adjustable shelves in open shelf cabinet. Locking doors on storage cabinet.

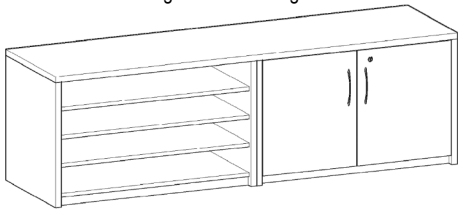

CAB-2060-22-OSSC-P	1534	60/1524	20/508	22/559	16.0/0.45	170/77
CAB-2072-22-OSSC-P	1580	72/1829	20/508	22/559	19.2/0.54	184/83

P - Specify pull handle style

Bookcase, box/file cabinet credenza. Three adjustable shelves in open shelf cabinet. One file drawer, one box drawer. Locking drawers on box/file cabinet.

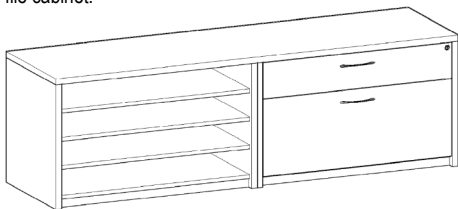

CAB-2060-22-OSBF-P	1708	60/1524	20/508	22/559	16.0/0.45	192/87
CAB-2072-22-OSBF-P	1754	72/1829	20/508	22/559	19.2/0.54	206/93

P - Specify pull handle style

**Seat Cushions**

Upholstered seat cushions for placement above credenzas are available in all Links Fabric options.

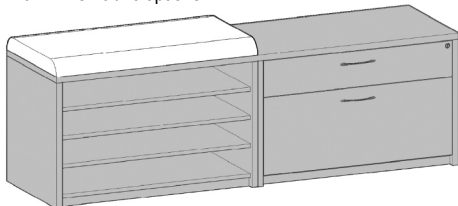

ACC-2024-SEAT	347	24/610	20/508
ACC-2030-SEAT	379	30/762	20/508
ACC-2036-SEAT	410	36/914	20/508

For additional specification instructions and pull handle options see pages 20-21. Refer to Links Fabric cards for available fabric selection.



**20" High Hutch (6" Posts)**

Hutch mounted on two 6" posts for hutches 18"-36" wide, four 6" posts for hutches 42" and wider. Center Divider included on hutches 42" and wider.

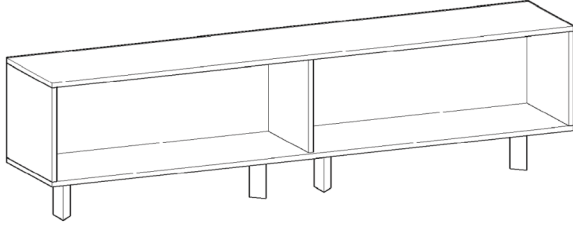

CODE	PRICE	WIDTH (in/mm)	DEPTH (in/mm)	HEIGHT (in/mm)	VOLUME (ft3/m3)	WEIGHT (lbs/kg)
TRPH-1418-20	460	18/457	14/356	20/508	0.6/0.02	13/6
TRPH-1424-20	505	24/610	14/356	20/508	0.8/0.02	16/7
TRPH-1430-20	552	30/762	14/356	20/508	1.0/0.03	19/9
TRPH-1436-20	593	36/914	14/356	20/508	1.2/0.03	24/11
TRPH-1442-20	637	42/1067	14/356	20/508	1.4/0.04	28/13
TRPH-1448-20	678	48/1219	14/356	20/508	1.6/0.05	32/15
TRPH-1454-20	724	54/1372	14/356	20/508	1.8/0.05	36/16
TRPH-1460-20	768	60/1524	14/356	20/508	2.0/0.06	40/18
TRPH-1466-20	810	66/1676	14/356	20/508	2.2/0.06	44/20
TRPH-1472-20	851	72/1829	14/356	20/508	2.4/0.07	48/22

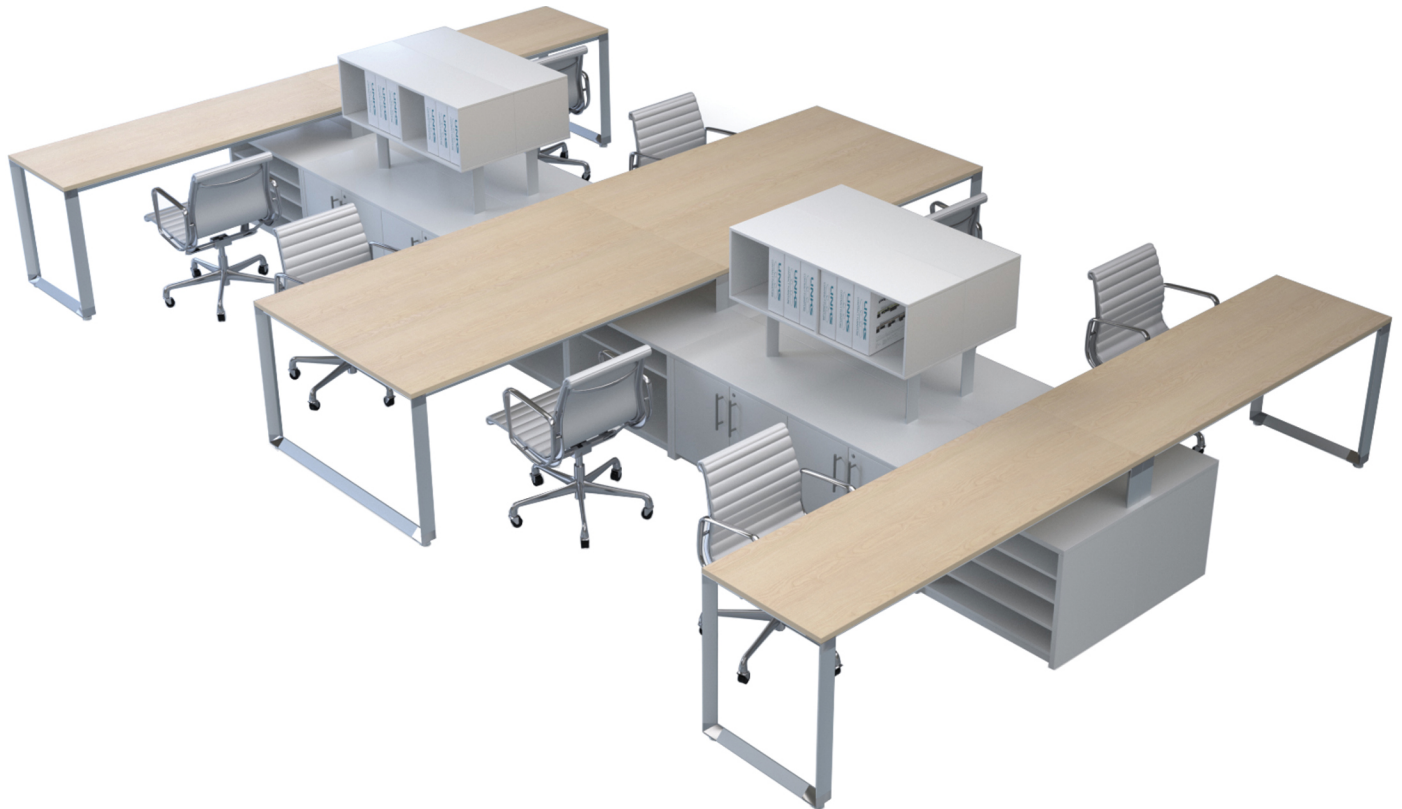

For additional specification instructions see pages 20-21.

CODE	PRICE				WIDTH (in/mm)	DEPTH (in/mm)	HEIGHT (in/mm)	VOLUME (ft3/m3)	WEIGHT (lbs/kg)
	(L)	(W)	(F)	(Z)					

**Divider Panel Set**

12"H Divider Panel.

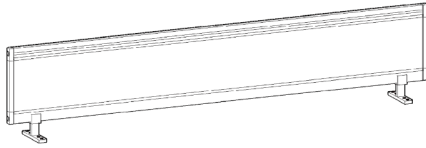

12" HIGH	TRPS-1224-	277	342	401	401	24/610	0.75/19	12/305	0.4/0.01	6/2.7
	TRPS-1230-	287	361	436	436	30/762	0.75/19	12/305	0.4/0.01	7/3.2
	TRPS-1236-	295	380	466	466	36/914	0.75/19	12/305	0.5/0.01	7/3.2
	TRPS-1242-	301	398	497	497	42/1067	0.75/19	12/305	0.6/0.01	7/3.2
	TRPS-1248-	310	419	528	528	48/1219	0.75/19	12/305	0.6/0.02	8/3.6
	TRPS-1254-	324	444	563	563	54/1372	0.75/19	12/305	0.7/0.02	8/3.6
	TRPS-1260-	341	466	590	590	60/1524	0.75/19	12/305	0.7/0.02	8/3.6
	TRPS-1266-	364	494	622	622	66/1676	0.75/19	12/305	0.8/0.02	9/4.1
TRPS-1272-	388	522	653	653	72/1829	0.75/19	12/305	0.8/0.02	9/4.1	

18"H Divider Panel.

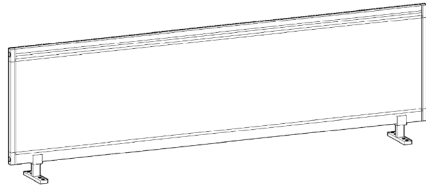

18" HIGH	TRPS-1824-	362	445	524	524	24/610	0.75/19	18/457	0.5/0.01	7/3.2
	TRPS-1830-	372	469	565	565	30/762	0.75/19	18/457	0.5/0.01	8/3.6
	TRPS-1836-	382	496	606	606	36/914	0.75/19	18/457	0.6/0.02	8/3.6
	TRPS-1842-	394	516	644	644	42/1067	0.75/19	18/457	0.7/0.02	8/3.6
	TRPS-1848-	401	542	685	685	48/1219	0.75/19	18/457	0.7/0.02	9/4.1
	TRPS-1854-	421	576	728	728	54/1372	0.75/19	18/457	0.8/0.02	9/4.1
	TRPS-1860-	444	606	767	767	60/1524	0.75/19	18/457	0.8/0.02	9/4.1
	TRPS-1866-	472	642	810	810	66/1676	0.75/19	18/457	0.9/0.03	10/4.5
TRPS-1872-	503	676	850	850	72/1829	0.75/19	18/457	0.9/0.03	10/4.5	

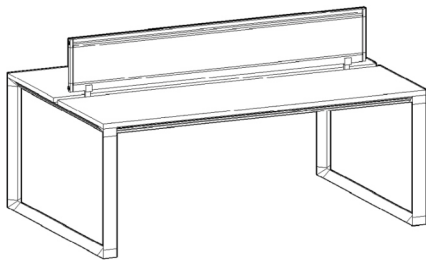

**Standard mounting using desk gap.**

Note: divider panels for Bench are recommended a size down. i.e. on a 72"W desk a 66" panel is generally standard.

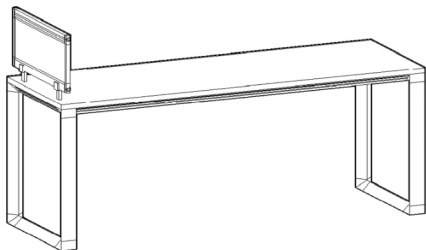
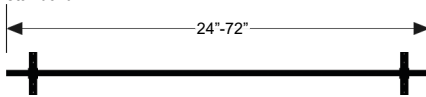

To specify Bench panels on desk ends, or surfaces that do not have a gap to accommodate panel mounting, specify "A" at end of panel code. i.e. TRPS-1224-F-A

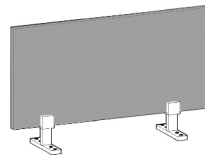
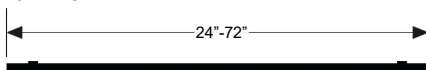

Laminate (L)  
 TRPS-\_\_\_\_-L  
 (see samples for finish colour selection)

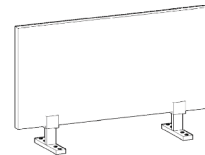

Whiteboard (W)  
 TRPS-\_\_\_\_-W

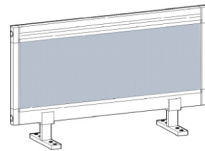

Fabric (F)  
 TRPS-\_\_\_\_-F  
 (see fabric cards for available selection)

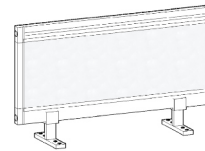

Frosted (Z)  
 TRPS-\_\_\_\_-Z

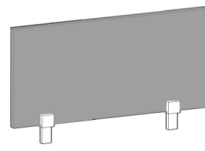

Laminate (L)  
 TRPS-\_\_\_\_-L-A  
 (see samples for finish colour selection)

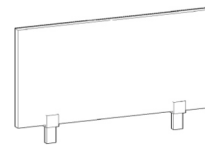

Whiteboard (W)  
 TRPS-\_\_\_\_-W-A

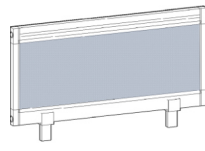

Fabric (F)  
 TRPS-\_\_\_\_-F-A  
 (see fabric cards for available selection)

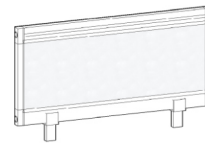

Frosted (Z)  
 TRPS-\_\_\_\_-Z-A

For additional specification instructions see pages 20-21. Refer to Links Fabric cards for available fabric selection.



**Wire Management Tray**

Two sizes available 18", and 48 for desks with widths of 48" and larger.

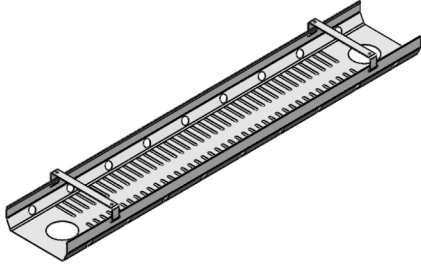

CODE	PRICE	WIDTH (in/mm)	DEPTH (in/mm)	HEIGHT (in/mm)	VOLUME (ft3/m3)	WEIGHT (lbs/kg)
------	-------	------------------	------------------	-------------------	--------------------	--------------------

TRWM-48	124	43/1092	7.25/184	3/76		3.8/2
TRWM-18	124	18/457	7.25/184	3/76		1.4/0.64

**Power/Data Center**

Metal Finish Electrical Port.



2 voice/data ports/housing  
 (jacks not included)

ELE-PORT-200	722	Please specify position when ordering				
Add <b>(-SL)</b> for Silver finish or <b>(-BK)</b> for Black finish						

Power Center. Plastic



1 Open Data/2 Power/1 Open Data

ELE-PORT-400	433	Please specify position when ordering				
Add <b>(-BK)</b> for Black finish or <b>(-WH)</b> for White finish						

**Bench Modesty Panels**

Modesty panels are specified by desk size.

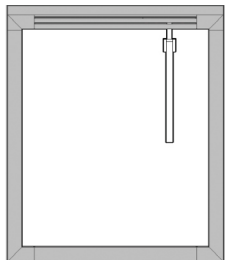
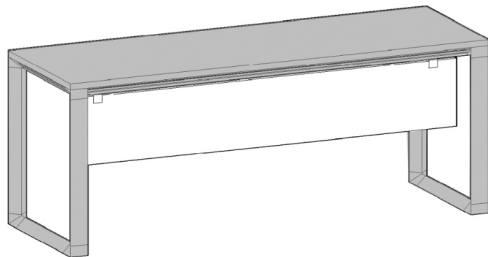

View from right side of desk

TR-MOD-36-L	287	30/762	0.75/19	12/305
TR-MOD-42-L	295	36/914	0.75/19	12/305
TR-MOD-48-L	301	42/1067	0.75/19	12/305
TR-MOD-54-L	310	48/1219	0.75/19	12/305
TR-MOD-60-L	324	54/1372	0.75/19	12/305
TR-MOD-66-L	341	60/1524	0.75/19	12/305
TR-MOD-72-L	364	66/1676	0.75/19	12/305
TR-MOD-36-Z	436	30/762	0.75/19	12/305
TR-MOD-42-Z	466	36/914	0.75/19	12/305
TR-MOD-48-Z	497	42/1067	0.75/19	12/305
TR-MOD-54-Z	528	48/1219	0.75/19	12/305
TR-MOD-60-Z	563	54/1372	0.75/19	12/305
TR-MOD-66-Z	590	60/1524	0.75/19	12/305
TR-MOD-72-Z	622	66/1676	0.75/19	12/305

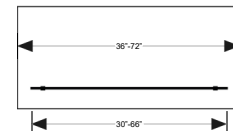

For additional specification instructions see pages 20-21.  
 See page 18 for ELE-PORT position placement specifications.

Links Contract Furniture’s non-sequential power system allows users to “daisy chain” multiple power centers together, requiring only one unit to be plugged into a wall outlet. This system works with the Links ELE-PORT-250 (Black) and ELE-PORT-260 (Silver) power and data port. The system enables a connection of up to 8 power/data centers off of one infeed. A three-way splitter allows users to extend or consolidate power access as needed. A smart LED indicator will illuminate green when everything is connected and ready, while a red light indicates that too many units have been linked.



**Features:**

- Customizable infeed cord lengths
- Non-sequential; arrange and re-arrange quickly and in any order.
- Multi-directional splitters
- UL 962 recognized



**Go Team!**

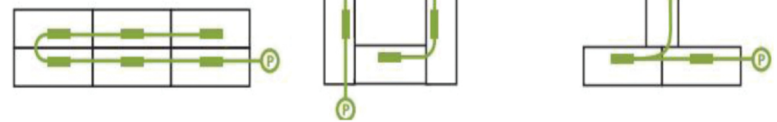

**Plug & Go**

A 15-amp plug infeed allows you to start almost anywhere



**A Mind Of Its Own**

iQ does the thinking, so you can just plug in and get to work



**Snap Together, Branch Out**

Modular connections and 3-way splitters make layouts easy

	CODE	PRICE	WIDTH (in/mm)	DEPTH (in/mm)	HEIGHT (in/mm)	VOLUME (ft3/m3)	WEIGHT (lbs/kg)
Daisy Chain Starter.	ELE-PORT-250-START	1627					
ELE-PORT-250 (Black)							
ELE-PORT-260 (Silver)	ELE-PORT-260-START	1627					

Surface mount power/data center with customizable cord lengths. Please specify position when ordering.  
ELE-PORT-250 (Black)  
ELE-PORT-260 (Silver)

ELE-PORT-250-24	992	24/610
ELE-PORT-260-24	992	24/610
ELE-PORT-250-36	1013	36/914
ELE-PORT-260-36	1013	36/914
ELE-PORT-250-48	1036	48/1219
ELE-PORT-260-48	1036	48/1219
ELE-PORT-250-60	1048	60/1524
ELE-PORT-260-60	1048	60/1524
ELE-PORT-250-72	1066	72/1829
ELE-PORT-260-72	1066	72/1829

**Surface mount electrical port comes standard with two (2) electrical receptacles and housing for optional voice/data plugs. Contact customer service for additional options.**

**Drawings must be provided with order.**

Refer to page 20 for electrical placement options.

**Racetrack Shape**

1" thick top with matching edge. 120"W to 192"W have two piece top.

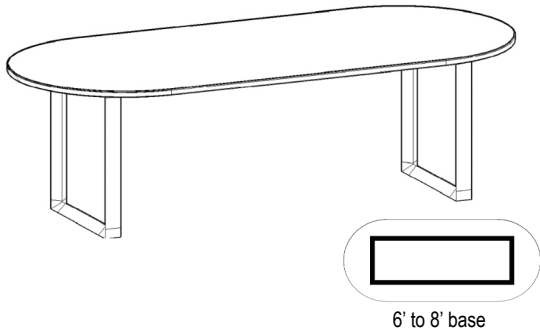

CODE	PRICE	WIDTH (in/mm)	DEPTH (in/mm)	HEIGHT (in/mm)	VOLUME (ft <sup>3</sup> /m <sup>3</sup> )	WEIGHT (lbs/kg)
------	-------	---------------	---------------	----------------	---	-----------------

TBL-0006-TRTR	1286	72/1829	36/914	29.5/749	4.5/0.13	100/45
TBL-0008-TRTR	1510	96/2438	42/1067	29.5/749	7.5/0.21	120/54
TBL-0010-TRTR	2238	120/3048	48/1219	29.5/749	10.5/0.30	160/73
TBL-0012-TRTR	2408	144/3658	48/1219	29.5/749	11.0/0.31	210/95
TBL-0014-TRTR	2839	168/4267	48/1219	29.5/749	11.5/0.33	240/109
TBL-0016-TRTR	3018	192/4877	48/1219	29.5/749	14.5/0.41	290/132
TBL-0006-TRTR-42	1415	72/1829	36/914	42/1067	5.5/0.13	110/50

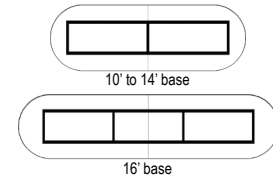
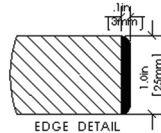

**Boat Shape**

1" thick top with matching edge. 120"W to 192"W have two piece top.

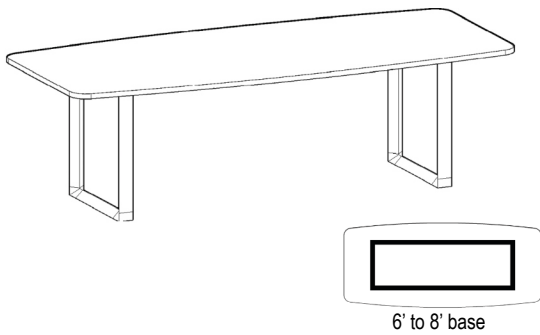

TBL-0006-BSTR	1286	72/1829	36/914	29.5/749	4.5/0.13	100/45
TBL-0008-BSTR	1510	96/2438	42/1067	29.5/749	7.5/0.21	120/54
TBL-0010-BSTR	2238	120/3048	48/1219	29.5/749	10.5/0.30	160/73
TBL-0012-BSTR	2408	144/3658	48/1219	29.5/749	11.0/0.31	210/95
TBL-0014-BSTR	2839	168/4267	48/1219	29.5/749	11.5/0.33	240/109
TBL-0016-BSTR	3018	192/4877	48/1219	29.5/749	14.5/0.41	290/132
TBL-0006-BSTR	1415	72/1829	36/914	42/1067	5.5/0.13	110/50

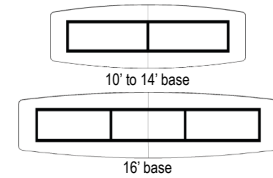
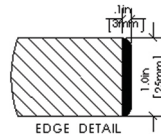

**Rectangular**

1" thick top with matching edge. 120"W to 192"W have two piece top.

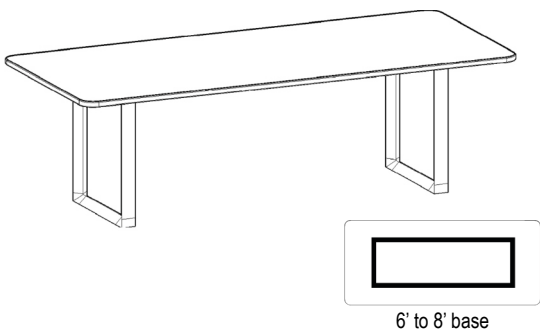

TBL-0006-RCTR	1286	72/1829	36/914	29.5/749	4.5/0.13	100/45
TBL-0008-RCTR	1510	96/2438	42/1067	29.5/749	7.5/0.21	120/54
TBL-0010-RCTR	2238	120/3048	48/1219	29.5/749	10.5/0.30	160/73
TBL-0012-RCTR	2408	144/3658	48/1219	29.5/749	11.0/0.31	210/95
TBL-0014-RCTR	2839	168/4267	48/1219	29.5/749	11.5/0.33	240/109
TBL-0016-RCTR	3018	192/4877	48/1219	29.5/749	14.5/0.41	290/132
TBL-0006-RCTR	1415	72/1829	36/914	42/1067	5.5/0.13	110/50

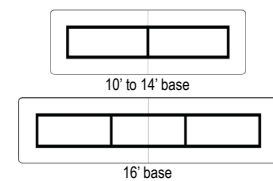
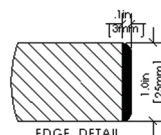

For additional specification instructions see pages 20-21.  
 Refer to pages 15-17 for electrical options.

**Round**

1" thick top with matching edge.

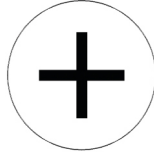
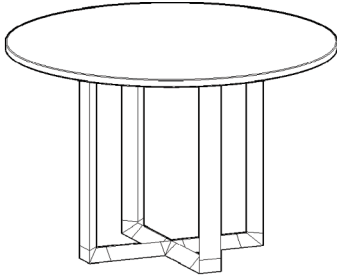

CODE	PRICE	WIDTH (in/mm)	DEPTH (in/mm)	HEIGHT (in/mm)	VOLUME (ft3/m3)	WEIGHT (lbs/kg)
------	-------	---------------	---------------	----------------	-----------------	-----------------

TBL-3030-RDTR	758	30/762	30/762	29.5/749	5/0.14	50/23
TBL-3636-RDTR	781	36/914	36/914	29.5/749	6/0.17	60/27
TBL-4242-RDTR	847	42/1067	42/1067	29.5/749	7/0.20	70/32
TBL-4848-RDTR	923	48/1219	48/1219	29.5/749	8/0.23	80/36
TBL-5454-RDTR	1292	54/1372	54/1372	29.5/749	9/0.25	90/41

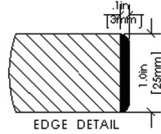

**Square Top**

1" thick top with matching edge.

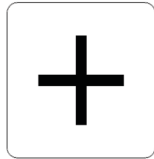
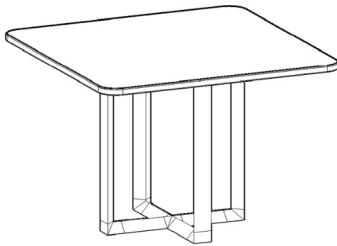

TBL-3030-SQTR	758	30/762	30/762	29.5/749	5/0.14	50/23
TBL-3636-SQTR	781	36/914	36/914	29.5/749	6/0.17	60/27
TBL-4242-SQTR	847	42/1067	42/1067	29.5/749	7/0.20	70/32
TBL-4848-SQTR	923	48/1219	48/1219	29.5/749	8/0.23	80/36
TBL-5454-SQTR	1292	54/1372	54/1372	29.5/749	9/0.25	90/41

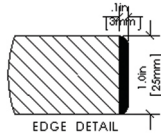

**End/Coffee Tables**

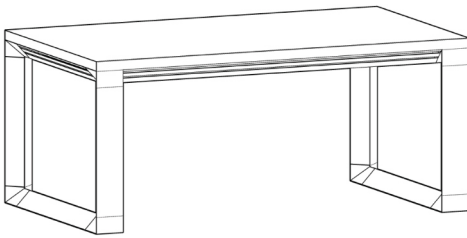

TBL-2024-ETTR	702	24/610	20/508	18/457		
TBL-2442-ETTR	736	42/1067	24/610	18/457		

**X-Base**

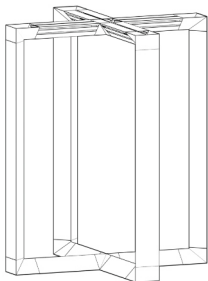

TR-20-XB-29	348	20/508	20/508	28/711		
TR-24-XB-29	374	24/610	24/610	28/711		
TR-30-XB-29	377	30/762	30/762	28/711		
TR-36-XB-29	637	36/914	36/914	28/711		
TR-20-XB-42	383	20/508	20/508	42/1067		
TR-24-XB-42	411	24/610	24/610	42/1067		
TR-30-XB-42	415	30/762	30/762	42/1067		
TR-36-XB-42	701	36/914	36/914	42/1067		

For additional specification instructions see pages 20-21.  
Refer to pages 15-17 for electrical options.

**Power/Data Center**

The ELE-PORT is a compact workspace accessory that provides convenient power and data distribution.

**Item Codes:**

ELE-PORT-100 (Black) & ELE-PORT-200 (Silver), ELE-PORT-250 (Black) & ELE-PORT-260 (Silver) daisy chain. See pages 15-17 for pricing/images.

**ELE-PORT Specifications:**

- ELE-PORT may be ordered on all worksurfaces.
- 10 foot black cord included.
- ELE-PORT are available in standard worksurface locations (shown below)
- ELE-PORTs may be placed in custom locations, a drawing is required indicating exact vertical and horizontal locations for the center of the cutout.

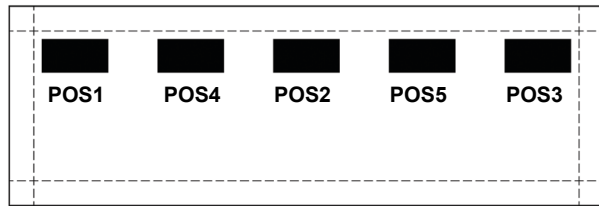

Cut-out placed on user side of beams/base.

**Grommet/ELE-PORT Position Codes**

- POS1** Left/Left User Side
- POS2** Center/Center User Side
- POS3** Right/Right User Side
- POS4** Left/Center User Side
- POS5** Right/Center User Side

**Grommets and Power/Data**

- Grommets are available in same locations as ELE-PORTS seen above.
- Grommets may be placed in custom locations, a drawing is required indicating exact locations.
- Grommets are not standard on Bench work-surfaces but may be added if requested. One grommet available on all worksurfaces at no upcharge. Add \$76 list for each additional grommet.
- Black or Silver available for both grommets and power/data units.



**ACC-OG-BK**  
**Black Grommet**  
(Standard)



**ACC-OG-SL**  
**Silver Grommet**  
(Optional)

**Thickness**

- Worksurfaces: 1" (25mm) thick/1 1/2" (38mm) thick.
- Drawer Fronts: 5/8" (16mm) thick.
- Doors: 5/8" (16mm) thick.
- Shelves: 5/8" (16mm) thick.

**Industry Standards**

- Greenguard Certified.

**Sizes and Weights**

- Weights are approximate and are not exact.
- Height does not include floor levelers. (some exceptions apply to height)

**Finishes / Color Specifications**

- Storage units may be ordered one-tone or two-tone.
- Legs and support beams available in Silver with Chrome accents.

**To Specify one-tone or two-tone colors:**

- First code denotes the worksurface, second code denotes the (cabinet) base/drawer/door/shelf color.
- To order one-tone color units, specify first code and second code identically. **i.e. CO/CO or CO - Cognac top with Cognac base.**
- To order two-tone color units, specify worksurface and (cabinet) base code separately. **i.e. CO/SA - Cognac top and fronts with Sahara base.**

**TOPS:**

- |                    |                       |
|--------------------|-----------------------|
| Nutmeg (NM)        | Chocolate Walnut (CW) |
| Cognac (CO)        | Cherry Henna (CH)     |
| Riviera Maple (RM) | Sahara (SA)           |
| True White (TW)    | Willow Gray (WG)      |
| Cappuccino (CP)    | Storm Gray (SG)       |
| Milky Way (MW)     | Gray (GR)             |
| Windy City (WC)    | London Fog (LN)       |
| Aspen (AP)         |                       |

**BASES (CAB):**

- |                    |                       |
|--------------------|-----------------------|
| Nutmeg (NM)        | Chocolate Walnut (CW) |
| Cognac (CO)        | Cherry Henna (CH)     |
| Riviera Maple (RM) | Sahara (SA)           |
| True White (TW)    | Willow Gray (WG)      |
| Chamois Black (BK) | Storm Gray (SG)       |
| Gray (GR)          | Cappuccino (CP)       |
| London Fog (LN)    | Milky Way (MW)        |
| Windy City (WC)    | Aspen (AP)            |

**ACCENTS:**

- Lime Burst (LB)
- Strawberry Fields (SF)
- Aqua Breeze (AB)

\*Accent colors can be used on anything made of 5/8" (16mm) laminate. Generally this is for drawer/door fronts, shelves, and Bench hutches.

**Worksurfaces and Beams**

- Worksurfaces are 1" (25mm) edged on all 4 sides.
- Leg and support beams are a 3" (76mm) anodized aluminum profiles available in silver only, with Chrome finish connectors.
- Worksurfaces are pre-drilled for connection to bases, and other components where applicable.
- Edges are user friendly, 3mm thick "Tough Guard" edged; beveled edges improve user comfort and product durability.
- Leveler shape is square body with rounded bottom, allowing for easy leveling of units and the additional space between frame and floor, minimizing moisture from carpet or floor.
- Floor levelers plastic base is 5/8" (16mm) high, with 1 1/4" (32mm) high threaded stem allowing 1" (25mm) height adjustment.

**Doors, Drawers, and Shelves**

- Drawer/Door fronts and shelves are 5/8" (16mm) thick solid core particle board finished on both sides with thermofused laminate.
- Drawer/Door fronts & shelves have 3mm thick "Tough Guard" edging on all 4 sides.
- Interior drawer construction in black finish.
- Drawers/Doors, open with front pull handles drilled 128mm apart, allowing for a wide comfortable grip.
- Box drawers, File drawers operate on ball bearing suspension slides for smooth and quiet operation.
- Box drawers operate on full extension ball-bearing slides, tested for 75lbs /34kg
- File drawers operate on full extension ball bearing slides, tested for 100lbs /45kg.
- File drawers are standard with file support rails, accepting letter or legal hanging files, allowing front to back or side to side filing.
- Drawers are 18" (457mm) depth.
- Cabinet doors operate on self closing hinges for smooth and quiet operation, are standard with 35mm half overlay and 40mm full overlay clip on hinges.
- Hutch doors are available in sliding option only.

**Lock Specifications**

- Locks are standard with an interchangeable lock core.
- Locks are standard in black and silver finishes.
- Locks are standard with collapsible key preventing damage to key.
- Lock core can be changed allowing multiple units to be keyed alike.
- Lock core can be changed allowing multiple units in a common area to be keyed differently (50 different cores available).
- One lock is standard on all locking cabinets
- Identical lock numbers are automatically supplied on the same unit.
- Core removable key available, master key available.
- Keys supplied with Microban Antimicrobial product protection

**Packaging**

- Assembled bases are packaged in corrugated cartons containing high recycled content.
- Worksurface edges and corners are reinforced with edge and corner protectors.
- Wood strapping supports the bottom portion of assembled units.

**Pull Handle Options**



**STANDARD "P1" PULL HANDLE**  
**Black Finish**



**Optional "P2" PULL HANDLE**  
**Silver Finish**



**Optional "P3" PULL HANDLE**  
**Silver Finish**



**Optional "P4" PULL HANDLE**  
**Silver Finish**



**Optional "P5" PULL HANDLE**  
**Brushed Nickel Finish**



**Optional "P6" PULL HANDLE**  
**Matte Black Finish**



**Optional "P7" PULL HANDLE**  
**Brushed Nickel Finish**

All above handles are for use with: lateral files, storage cabinets and other items, such as serving carts and wardrobes, manufactured by Links Contract Furniture Inc.. Please specify the handle of your choice on your purchase order. Orders will be processed with the standard P1 handle if not specified on your order.

**Notification:**

We are constantly upgrading our products. For the most up-to date product specifications, please contact Customer Service.

## Links Contract Furniture Values

We value our customers. We are responsible to the consumers who use our products. Therefore, in meeting the needs of our consumers we are committed to delivering the upmost quality products and providing business excellence as the base of everything we do. We promise to listen closely to the needs of our consumers and strive to continuously exceed expectations.

At Links we recognize our members. An organization is only effective as its people. Therefore, employee development is an essential element of company growth. As an organization we believe in the ability of our people and stand behind them in achieving their greatest potential.

We value integrity. We believe in developing integrity in the deepest layers of our organization and not just at its surface. We strive to build mutually beneficial relationships with our customers, dealers, and suppliers as a foundation for growth.

We value continuous learning. We believe in growth through experience. A constant evolution in the way we think and act brings about new knowledge and skills that allow us to develop improved processes, advanced designs, and reduce our environmental impact.

We value our world. We work to cultivate the world in which we live in through investing in our people and the pursuit of sustainable development. Focusing our value chain on the challenges of sustainable development has allowed us to find new ways to minimize our impact on the environment.





Links Contract Furniture Inc.  
undoubtedly achieves to supply  
every office scheme with the  
newest in office furniture design and  
a splash of colour for that unique,  
corporate look.

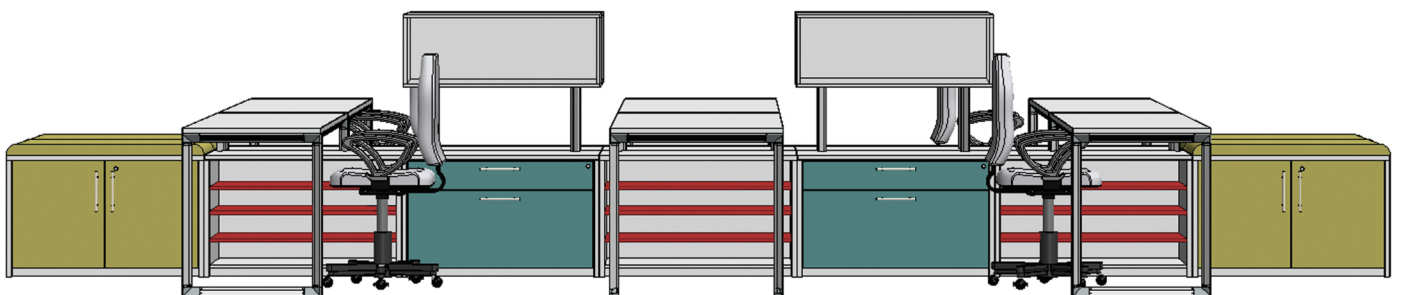



LINKS' Creative Solutions . . . The Industry Leader!



While every effort is made to ensure the accuracy of information contained in this price list at the time of publication, we cannot accept responsibility for inaccuracies resulting from printing errors or omissions. We reserve the right to make product improvements and price changes without notice.

© Copyright 2022 Links Contract Furniture Inc.. All Rights Reserved.

Head Office/Showroom: 141 Cidermill Ave, Unit #1 Concord, Ontario Canada L4K 4G5  
Local & International: P: 416.745.8910  
Toll Free - North America: P: 855-50-LINKS (855.505.4657)  
Email: info@linkscontract.com  
Website: linkscontract.com

